

Engineering office for temporary structures,
exhibition and entertainment technology

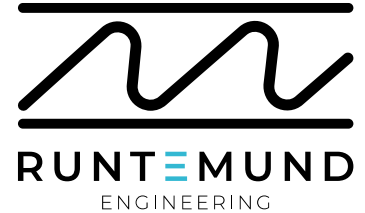

Runtemund Engineering
Dipl.-Ing. Uwe Runtemund
Waldstraße 51
76133 Karlsruhe
GERMANY

Phone +49 (0) 721 / 16 11 99 80
E-Mail info@runtemund.de
Web runtemund.de

Structural Analysis

Project project number 23GLT01
project name Stage Deck Hand Rail

Client company Global Truss GmbH
street Im Stöckmädle 27
postal code + city 76307 Karlsbad
country GERMANY

Operator company
street
postal code + city
country

Issuer

25/01/2023, Dipl.-Ing. Uwe Runtemund
Licensed structural engineer
Chamber of Engineer NRW, # 747230

This structural report is prepared exclusively for the customer/operator of the construction. The document is only valid with original signature and seal for one execution. Copies – electronic or paper – are illegal.

Revisions

25.01.2023 Initial Version

Runtemund Engineering asks for a separate copy of the inspection report, if this analysis has been checked. Please send the report with specifying the project number below to:

Runtemund Engineering

Waldstraße 51

76133 Karlsruhe

GERMANY

info@runtemund.de

Note to digital Version

The PDF-Document of this analysis can contain interactive content beside visible page content. This interactive elements are usable on an appropriate electronic devices, partially only with Adobe Acrobat Reader.

Table of contents

1 User Information	3
1.1 Object description	3
1.2 Installation and operating instructions	4
2 Structural Analysis	5
2.1 Basis of calculation	5
2.2 Used software	5
2.3 System assumptions	5
2.4 Load assumptions	6
2.4.1 Self-weight	6
2.4.2 Live loads	6
2.4.3 Other or special loads	6
2.4.4 Load combinations	6
2.5 Structural checks (STR)	7
2.5.1 Post profile RHS 60x40x3 S355 (EN 10219-2)	7
2.5.2 Handrail CHS 42,4x2,6 S235 (EN 10219-2)	9
2.5.3 Connection to the deck	10
2.6 Stability checks (EQU)	13

1 User Information

1.1 Object description

Subject of this analysis is a handrail for a stage deck system with a load of 1.0 kN/m.

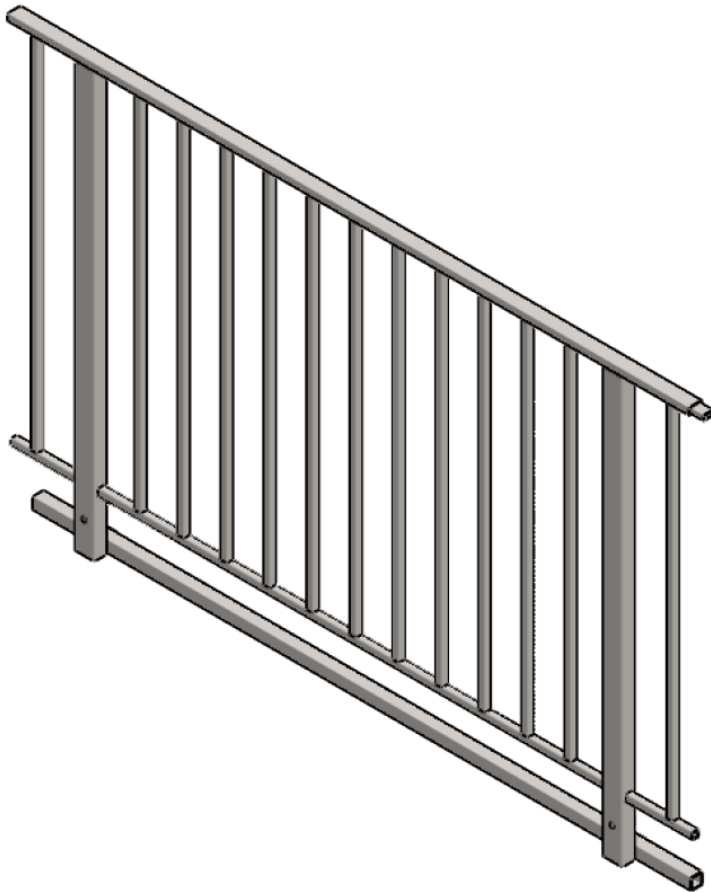

1.2 Installation and operating instructions

The analysis was made according to the current state of the art. There are no concerns about load bearing capacity and stability as long as the notes in this chapter are observed and implemented.

The following points must be observed from structural point of view, unaffected by other safety requirements:

General notes

- The assembly and operation of the construction occurs in a professional manner. In particular, the staff is qualified for their activities and is trained in the special characteristics of the construction.
- All joints have to be secured against self-loosening.
- The substructure (stage deck) is not subject of this calculation. Sufficient load-bearing capacity must be ensured by the customer.
- It has to be ensured by the customer that the design of the used components correspond to the drawings and assumptions of this structural analysis. Especially if manufacturers make changes to their components without prior notice.
- The installation and operating instructions of the manufacturer of the corresponding parts have to be considered.

Specific notes

- The dimensions of the post profile was changed to a similar profile which is sufficient enough.
- The profile of the handrail was changed to a sufficient circular hollow section to prevent people from placing objects on the railing.
- The maximum eccentricity of the post to the leg of the stage deck must be 5 cm.
- To transmit forces in counter direction an additional bracket must be connected between contact bar and stage deck leg.
- Further notes within this document have to be considered.

2 Structural Analysis

2.1 Basis of calculation

In general the structural analysis was made according to the current state of the art. In particular, the following literature and publications are used:

DIN EN 1990 - Eurocode 0 - Basis of structural design

DIN EN 1993 - Eurocode 3 - Design of steel structures

DIN EN 1999 - Eurocode 9 - Design of aluminium structures

DIN 15921 Entertainment Technology - Aluminium platforms and frames

2.2 Used software

The calculation is done by using specialized engineering software for structural analysis: Jameo AutoStatics for structural analysis in general and Jameo Engineer for framework analysis and finite element Analysis. An electronic report of the external analyses are annexed to this document if relevant.

2.3 System assumptions

The analysis is general based on first-order theory. Stability checks shall be done, where necessary, by appropriate methods. The analysis according to Th.I.O. is sufficiently accurate for the given geometry.

Main subject of this analysis is the design of the handrail itself. It is strongly recommended to test the bearing capacity of the handrail to the stage deck.

2.4 Load assumptions

In order to ensure safe operation of the construction, the loads assumed in this chapter must not be exceeded.

2.4.1 Self-weight

The self-weight is not considered, it is not relevant.

2.4.2 Live loads

According to DIN 15921 4.4.3 handrail height is min. 1.1 m.

Load in fall direction	$q_1 =$	1	kN/m
Load in counter direction	$q_2 =$	0,5	kN/m

2.4.3 Other or special loads

No other loads are considered.

2.4.4 Load combinations

Load combinations are done according to DIN EN 1990.

Structural checks (STR) according to DIN EN 1990

Permanent loads	$\gamma_G =$	1,35
Variable loads	$\gamma_Q =$	1,5
Accidental loads	$\gamma_A =$	1,0

Stability checks (EQU) according to DIN EN 1990

Favorable self-weight	$\gamma_G =$	0,95
Unfavorable self-weight	$\gamma_G =$	1,05
	$\gamma_Q =$	1,5

2.5 Structural checks (STR)

All parts, which are not checked because of their safety-related little importance, must be dimensioned adequately.

The design is done for an 2,0m Element. Shorter Elements are possible if geometric dimensions and design principles are respected.

2.5.1 Post profile RHS 60x40x3 S355 (EN 10219-2)

System

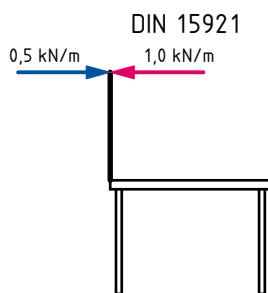

Internal Forces

Design Moment (2,0 m handrail, per side)

$$M_{Ed} = 1,5 \times (1260 \text{ mm} - 91,5 \text{ mm}) \times 1,0 \text{ kN/m} \times \frac{2 \text{ m}}{2} \quad M_{Ed} = 1,75 \text{ kN}\cdot\text{m}$$

The design shear force assume a minimum distance for the contact points for the mounting point.

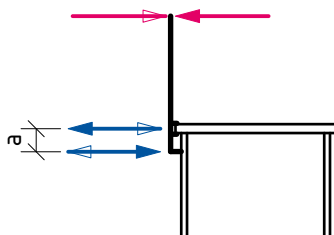

$$V_{Ed} = \frac{1,75 \text{ kN}\cdot\text{m}}{91,5 \text{ mm}}$$

$$a_{min} = 91,5 \text{ mm}$$

$$V_{Ed} = 19,16 \text{ kN}$$

Verifications in ultimate limit state (ULS)

Bending profile

Bending design resistance (net with hole)

$$M_{Rd} = (6,72 \text{ cm}^3 - 2 \times 12,5 \text{ mm} \times 3 \text{ mm} \times 18,5 \text{ mm}) \times \frac{35,5 \text{ kN/cm}^2}{1,0}$$

$M_{Rd} = 1,89 \text{ kN}\cdot\text{m}$

Check

$$\eta = \frac{1,75 \text{ kN}\cdot\text{m}}{1,89 \text{ kN}\cdot\text{m}} < 1,0$$

$\eta = 0,93 \quad \checkmark$

Shear profile

Shear design resistance

$$V_{Rd} = 2,4 \text{ cm}^2 \times \frac{35,5 \text{ kN/cm}^2}{1,0 \times \sqrt{3}}$$

$V_{Rd} = 49,19 \text{ kN}$

Check

$$\eta = \frac{19,16 \text{ kN}}{49,19 \text{ kN}} < 1,0$$

$\eta = 0,39 \quad \checkmark$

Execution instructions

- The dimensions of the post profile was changed to a similar profile which is sufficient enough.

2.5.2 Handrail CHS 42,4x2,6 S235 (EN 10219-2)

System

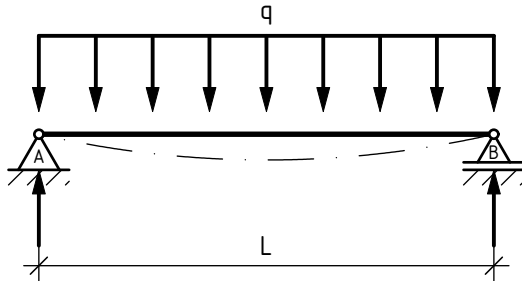

Internal forces

$$M_{Ed} = 1,5 \times 1 \text{ kN/m} \times \frac{1,8 \text{ m}^2}{8}$$

$$M_{Ed} = 0,34 \text{ kN}\cdot\text{m}$$

Verifications in ultimate limit state (ULS)

Bending profile

$$M_{Rd} = 3,05 \text{ cm}^3 \times \frac{23,5 \text{ kN/cm}^2}{1,0}$$

$$M_{Rd} = 71,67 \text{ kN}\cdot\text{cm}$$

Check

$$\eta = \frac{0,34 \text{ kN}\cdot\text{m}}{71,67 \text{ kN}\cdot\text{cm}} < 1,0$$

$$\eta = 0,47 \quad \checkmark$$

Execution Instructions

- The profile of the handrail was changed to a sufficient circular hollow section to prevent people from placing objects on the railing.

2.5.3 Connection to the deck

The connection to the stage deck must be stable enough to transmit the occurring forces in both direction (fall direction/counter direction). Minimum distance at connection point is already defined.

Minimum distance	$a_{\min} =$	91,5	mm
Contact Force	$V_{Ed} =$	19,16	kN

Verification in ultimate limit state (ULS)

Bolt M10 8.8

Design resistance	$F_{t,Rd} =$	33,4	kN
-------------------	--------------	------	----

Check

$$\eta = \frac{19,16 \text{ kN}}{33,4 \text{ kN}} < 1,0 \quad \eta = 0,57 \quad \checkmark$$

Slot nut 50x6 S235

The slot nut is a 50 mm wide, 6mm thick steel plate with a M10 thread. For calculation it is assumed that 1xp is not bearing.

Shear resistance thread

$$V_{Rd} = \pi \times 8,6 \text{ mm} \times (6 \text{ mm} - 1,5 \text{ mm}) \times \frac{36 \text{ kN/cm}^2}{1,25 \times \sqrt{3}} \quad V_{Rd} = 20,22 \text{ kN}$$

According to VDI 2230-1

$$V_{Rd} = 20,1 \text{ kN}$$

Check

$$\eta = \frac{19,16 \text{ kN}}{20,1 \text{ kN}} < 1,0 \quad \eta = 0,95 \quad \checkmark$$

Stage deck profile EN AW 6005A

An effective bearing width of 45mm of the slot nut is assumed.

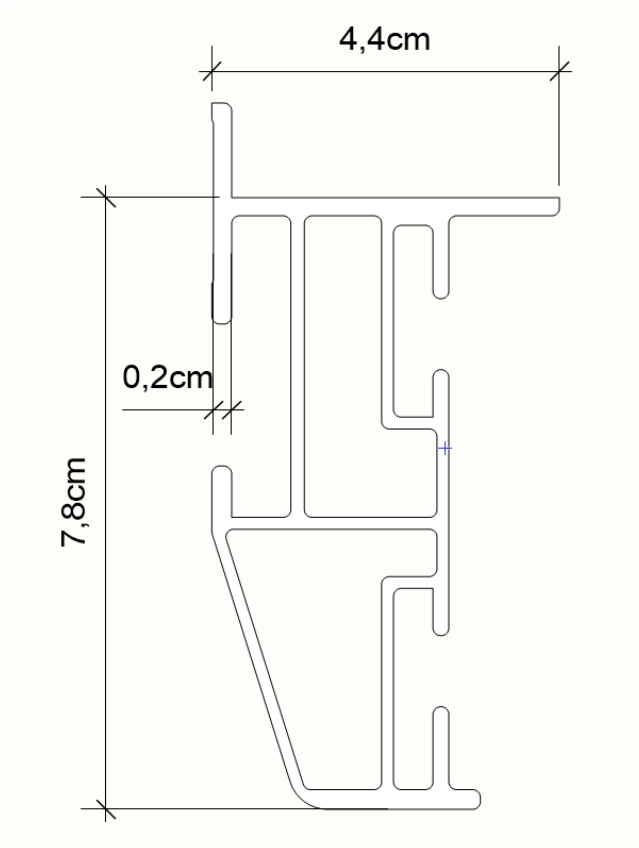

Shear resistance stage deck profile

$$V_{Rd} = 2 \times 45 \text{ mm} \times 2 \text{ mm} \times \frac{215 \text{ N/mm}^2}{1,1 \times \sqrt{3}}$$

$$V_{Rd} = 20,31 \text{ kN}$$

Check

$$\eta = \frac{19,16 \text{ kN}}{20,31 \text{ kN}} < 1,0$$

$$\eta = 0,94 \quad \checkmark$$

Due to complex profile geometry we strongly recommend to test tensile break force of this connection.

Contact bar RHS 34x34x2 S235

Design Resistance

$$M_{pl,Rd} = 4,1 \text{ cm}^3 \times \frac{23,5 \text{ kN/cm}^2}{1,0}$$

$$M_{pl,Rd} = 96,35 \text{ kN}\cdot\text{cm}$$

Maximum connection eccentricity

$$e = \frac{96,35 \text{ kN}\cdot\text{cm}}{19,16 \text{ kN}}$$

$$e = 5,03 \text{ cm}$$

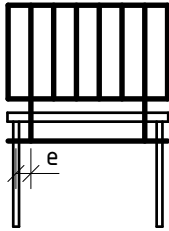

Execution instructions

- The maximum eccentricity of the post to the leg of the stage deck must be 5 cm.
- To transmit forces in counter direction an additional bracket must be connected between contact bar and stage deck leg.

2.6 Stability checks (EQU)

Stability check for the handrail itself is not necessary.

SICHERHEITSGELÄNDER 2M FÜR GT STAGE DECK

115207

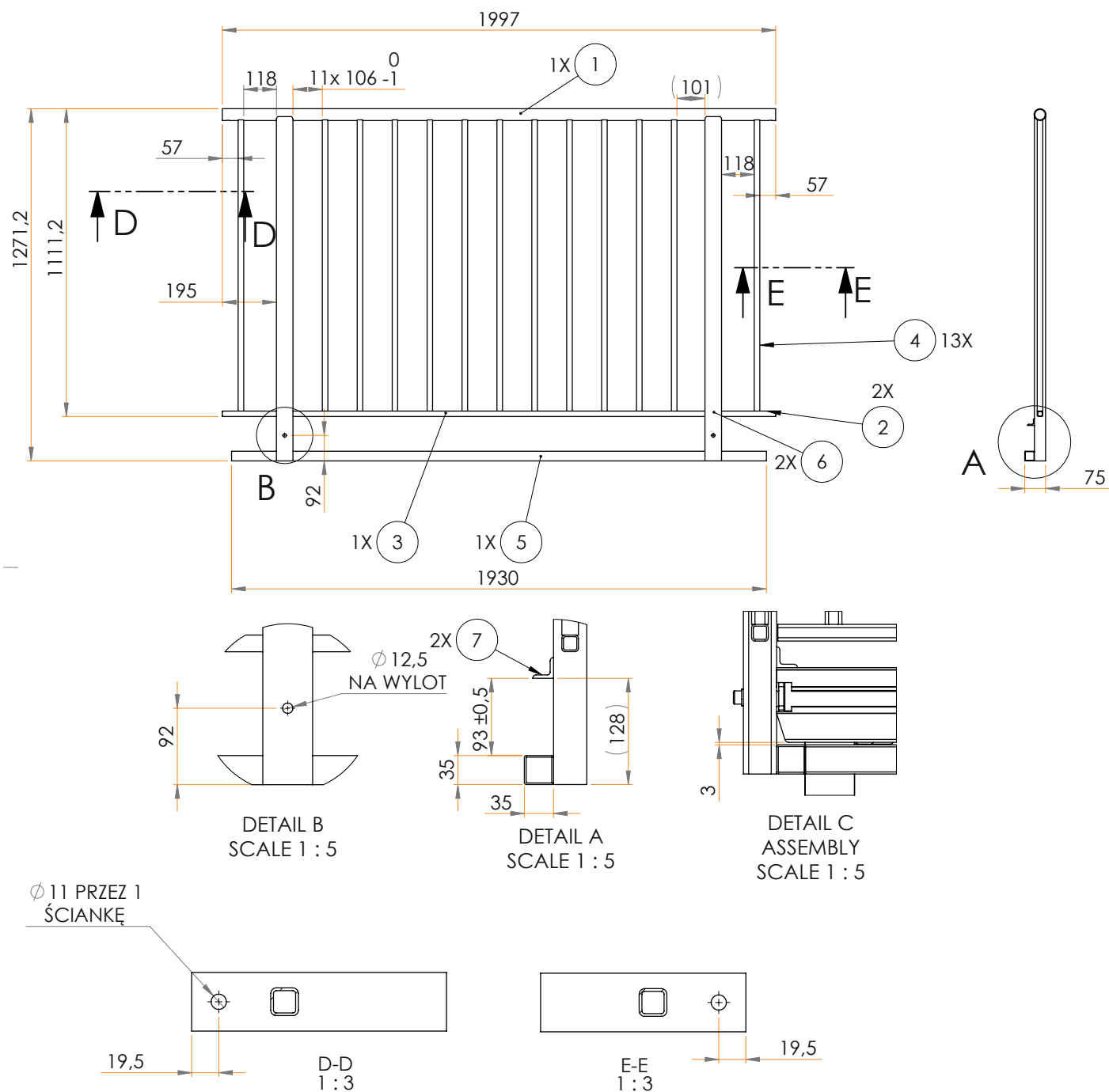

MONTAGEEINSATZ FÜR HANDLAUF

102040

